

Name of Student

Roll No.

Problem 1

17 Marks

1.1

$$X = 1.34 \text{ V}$$

$$Y = -0.408 \text{ V}$$

1.2

$$\Delta G = -222915 \text{ J} < 0$$

 \Rightarrow Cr (IV) disproportionates.

Correct E calculation and inference also awarded marks

1.3

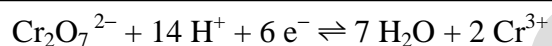

1.4

 -0.27V is the change in potential.

1.5

$$E_{\text{sy}} = 1.140 \text{ V}$$

1.6

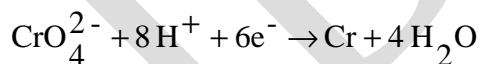

$$\% \text{ Efficiency} = 6.87 \%$$

1.7

The reaction at the cathode is $2 \text{H}_3\text{O}^+ + 2 \text{e}^- \rightarrow 2 \text{H}_2\text{O} + \text{H}_2$ The reaction at the anode is $6 \text{H}_2\text{O} \rightarrow 4 \text{H}_3\text{O}^+ + 4 \text{e}^- + \text{O}_2$. $v(\text{H}_2) = 6.69 \text{ m}^3$ of hydrogen. $v(\text{O}_2) = 3.50 \text{ m}^3$ of oxygen.

1.8

$$\% \text{ of Cu } (\text{C}_{18}\text{H}_{33}\text{O}_2)_2 = 23 \%$$

Problem 2

11 Marks

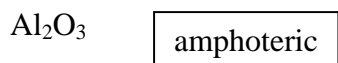
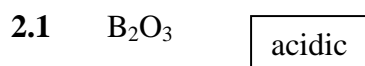

2.2

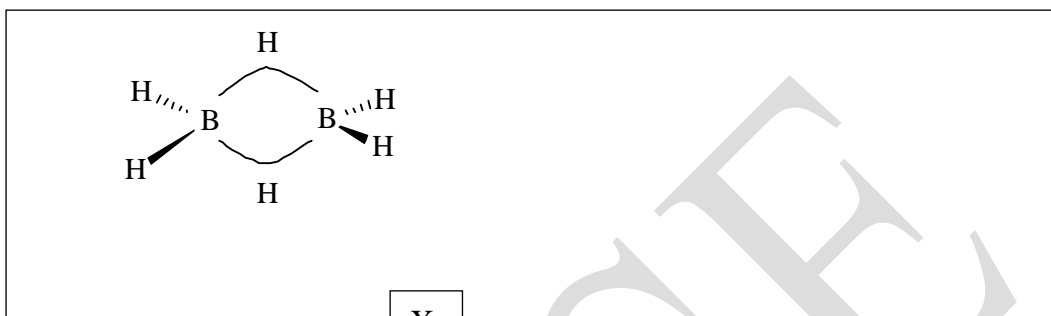

b) Three centered $2e^-$ bond

2.3

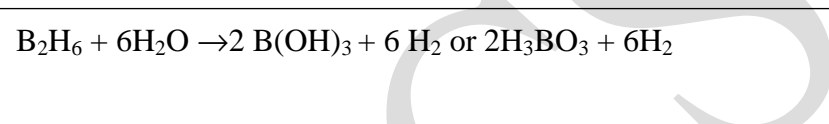

2.4

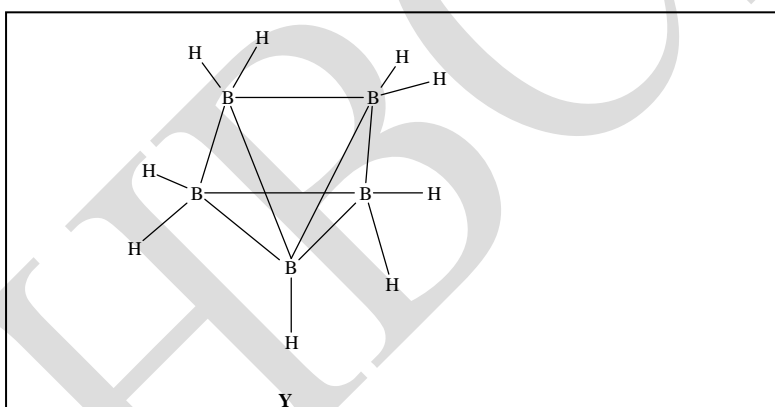

2.5

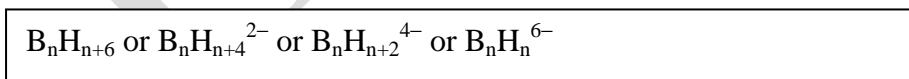

2.6

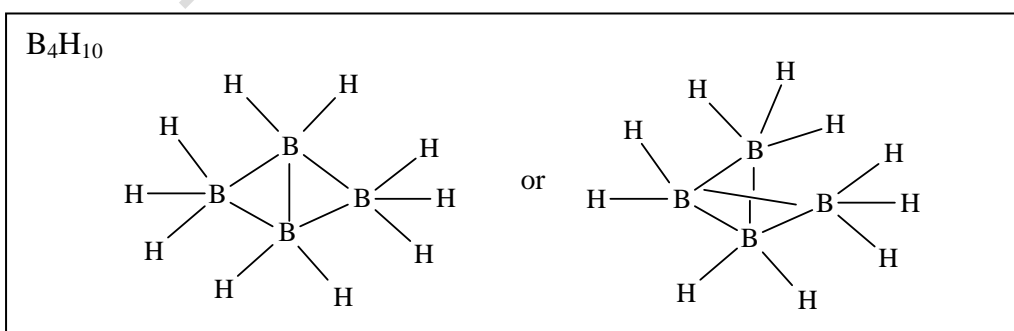

2.7

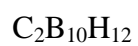

Z

2.8

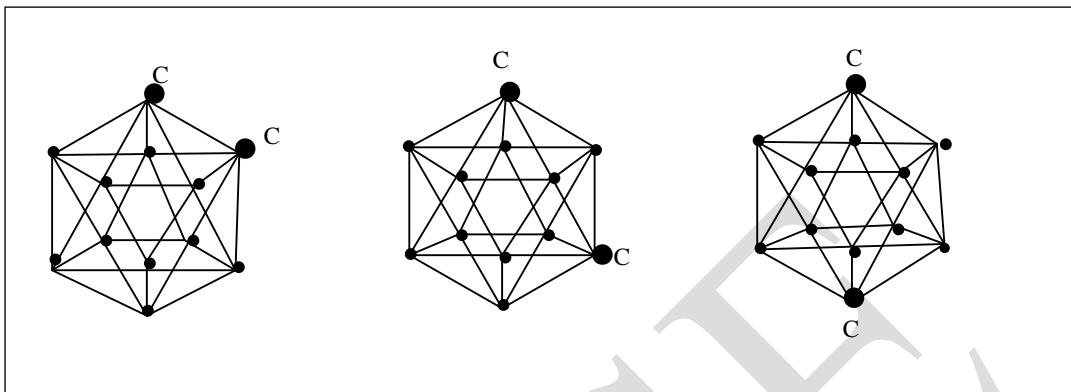

Problem 3

18 Marks

Thermodynamics of a sustainable bio process

3.1

Efficiency = 32.6%

3.2

Decrease in the level of CO₂ (in ppm) = 2.56×10^5 ppm

3.3

 $\Delta H_f = -1271.4 \text{ kJ}$

3.4

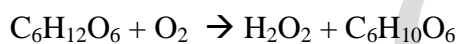

3.5

Change in current produced = $0.672 \times 10^{-3} \text{ mA}$

3.6

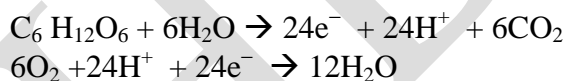

3.7

 $E = 1.24 \text{ V}$

3.8

 $dE/dT = 7.82 \times 10^{-5} \text{ VK}^{-1}$

3.9

Time = 5.597 or 6.0 min

3.10 $dU_s = T_s dS \quad dG_s = 0$

3.11 $(\Delta U)_s = -60N_A hc/\lambda$. $(\Delta U)_{PO} = 60N_A hc/\lambda$
Or $(\Delta U)_s = -60hc/\lambda$. $(\Delta U)_{PO} = 60hc/\lambda$

3.12 $(\Delta S)_{\text{step1}} = 60N_A hc/\lambda (1/T_{PO} - 1/T_s)$
or $(\Delta S)_{\text{step1}} = 60hc/\lambda (1/T_{PO} - 1/T_s)$

3.13 $(\Delta S)_{\text{step2}} = -\Delta G_{PO}/T$

3.14 Show that $\Delta S_{\text{step3}} = 0$

In step 3 sun does not participate.

ΔU_{PO} in step 3 = $(\Delta U_{PO}$ in step 1 - ΔU_{PO} in step 2) = the energy transmitted to the earth

$(\Delta U_{PO}(\text{step1}) - \Delta G_{PO})/T_{PO}$ is the change in entropy of PO

Change in entropy of earth = $-(\Delta U_{PO}(\text{step1}) - \Delta G_{PO})/T_E$

Adding ΔS_E and ΔS_{PO} and since $T_E = T_{PO}$ $\Delta S_{\text{step3}} = 0$

3.15 $\Delta S(\text{overall}) = (60N_A hc/\lambda - \Delta G_{PO})/T_{PO}$

or $\Delta S(\text{overall}) = (60hc/\lambda - \Delta G_{PO})/T_{PO}$

Problem 4

23 marks

Organosulphur Compounds

4.1

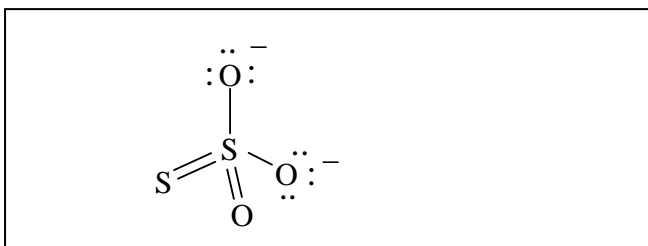

4.2

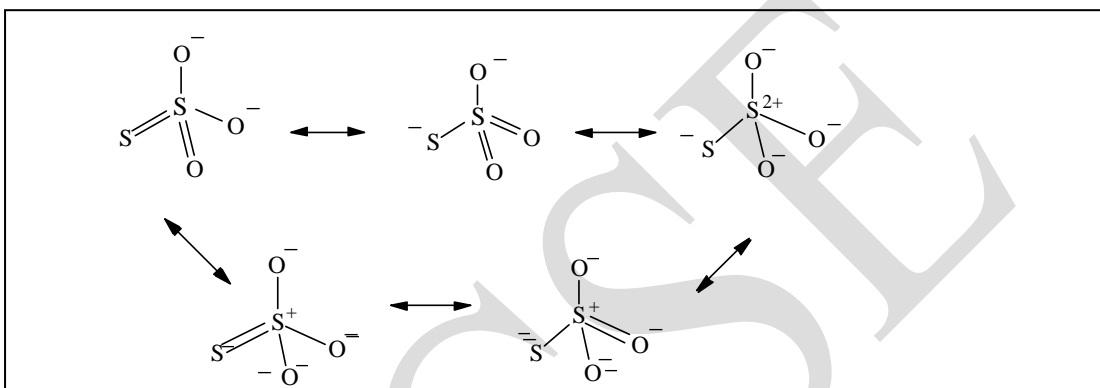

4.3

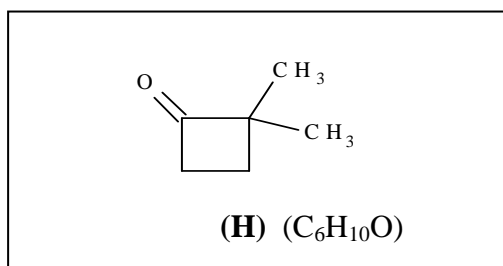
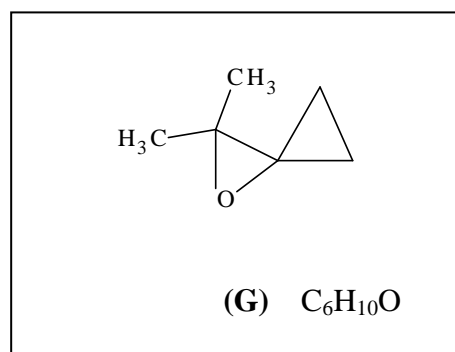
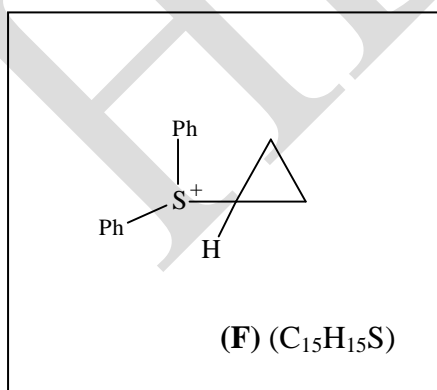
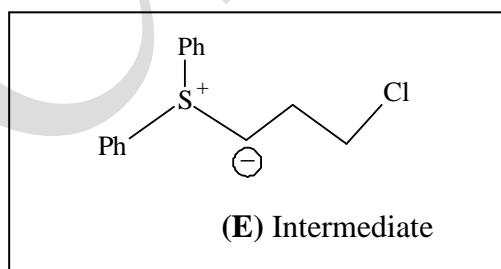
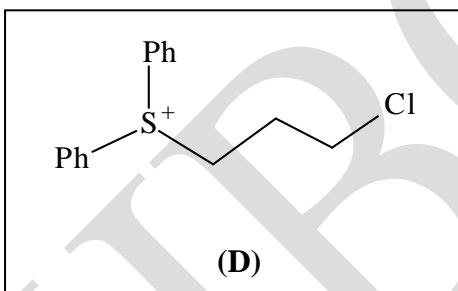

4.4

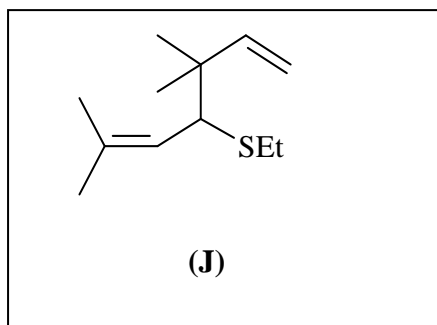

4.5

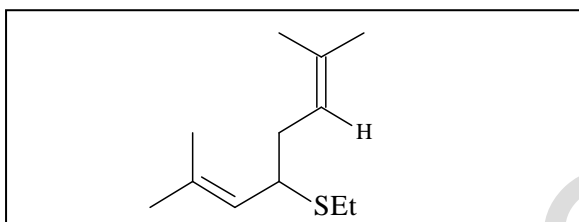

4.6

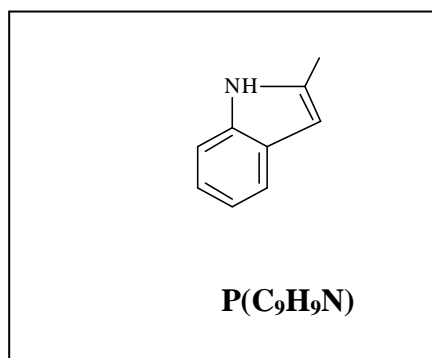
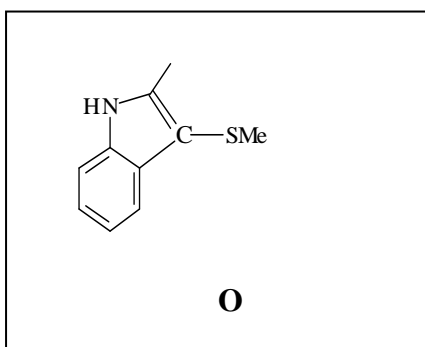
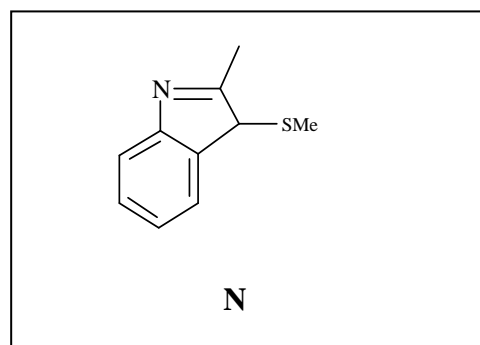
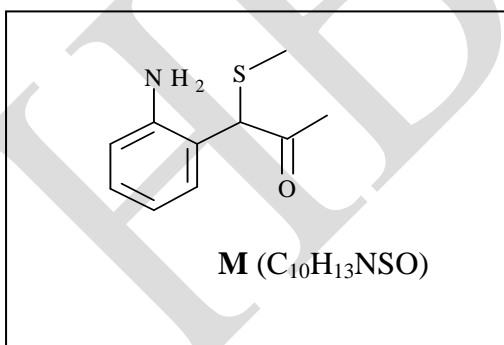
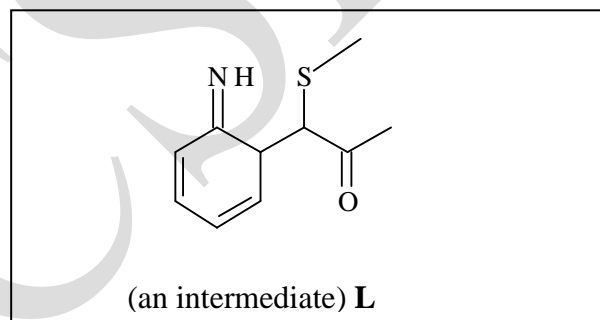
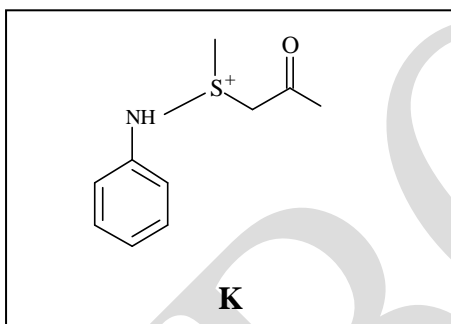

4.7

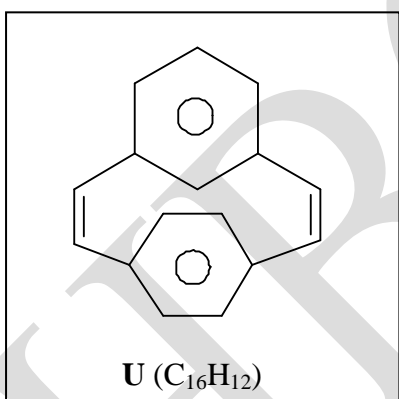
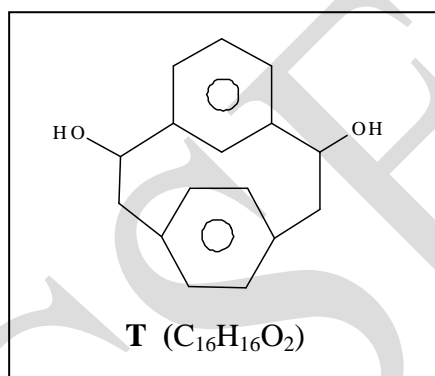
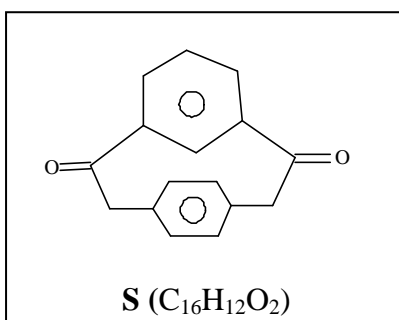
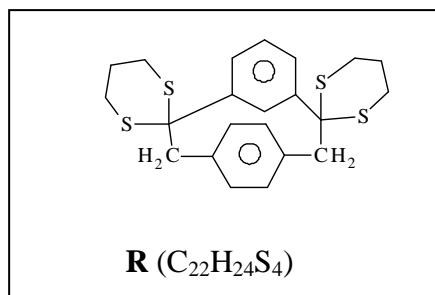
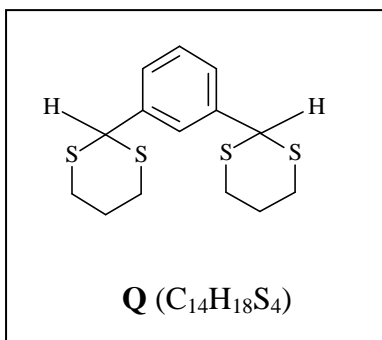

Problem 5

17 marks

A. Chemistry of Main Group Elements

5.1 a)

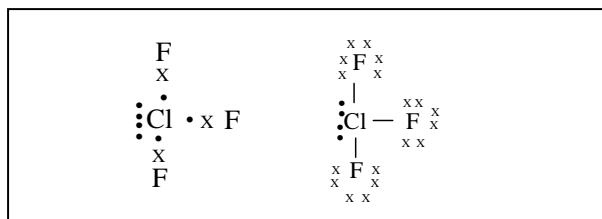

b)

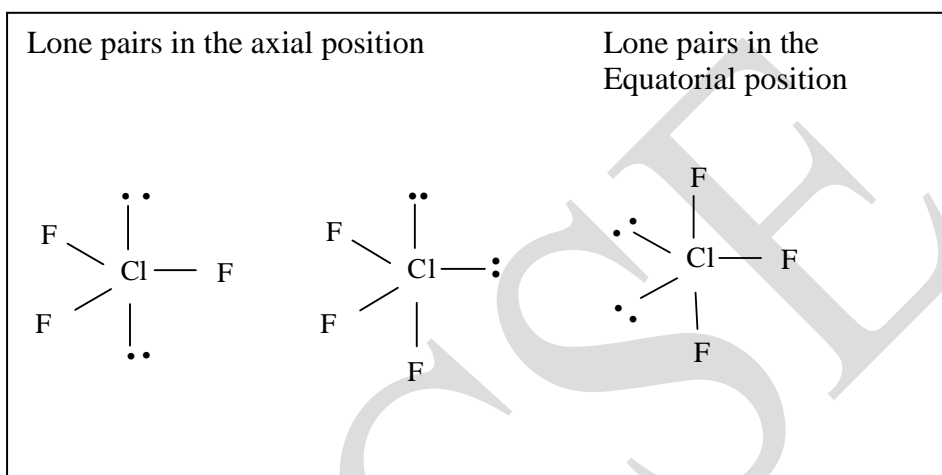

c).



5.2 a)

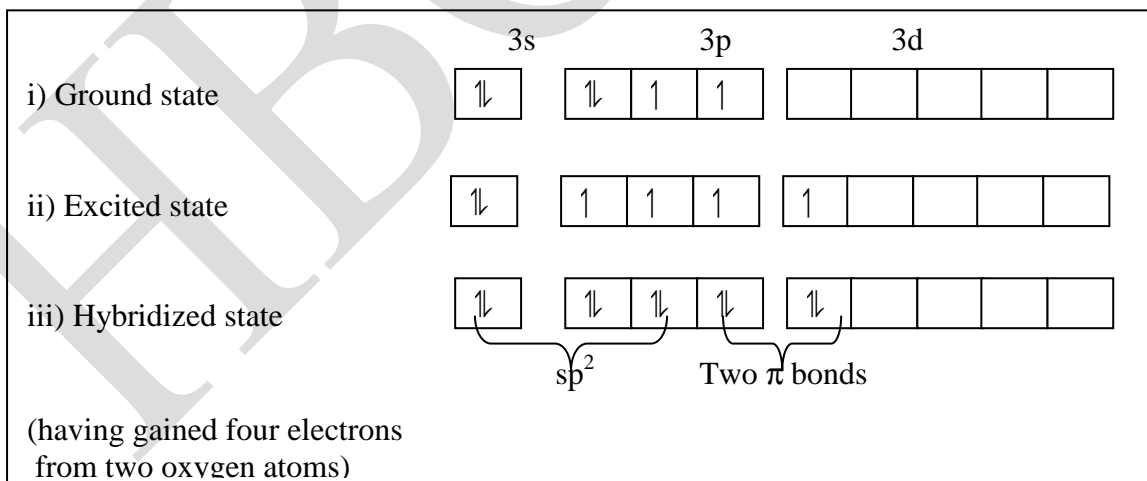

b)

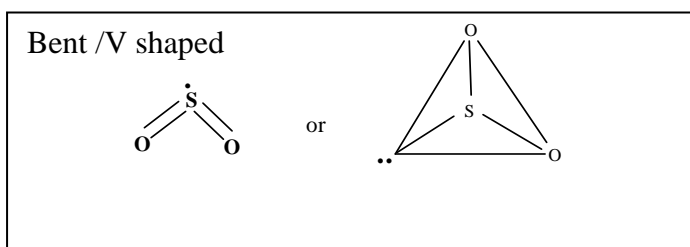

c) No



- 5.3 i) b) Sn^{4+} is more stable than Sn^{2+} X
- c) Pb^{2+} is more stable than Pb^{4+} X
- ii) oxidizing agent X

iii) **This sub part was found to be Ambiguous – Hence Omitted**

B. Chemistry of d and f- block elements

5.4

Complex	No of unpaired electrons	Spin state
$[\text{Fe}(\text{CN})_6]^{4-}$	0	Diamagnetic/low spin
$[\text{Fe}(\text{CN})_6]^{3-}$	1	Low spin
$[\text{FeCl}_4]^-$	5	High spin
$[\text{Fe}(\text{H}_2\text{O})_6]^{2+}$	4	High spin

5.5

0.0 B.M

- 5.6 i) a) the central metal ion is in higher oxidation state. X
- b) Ir belongs to third transition series. X

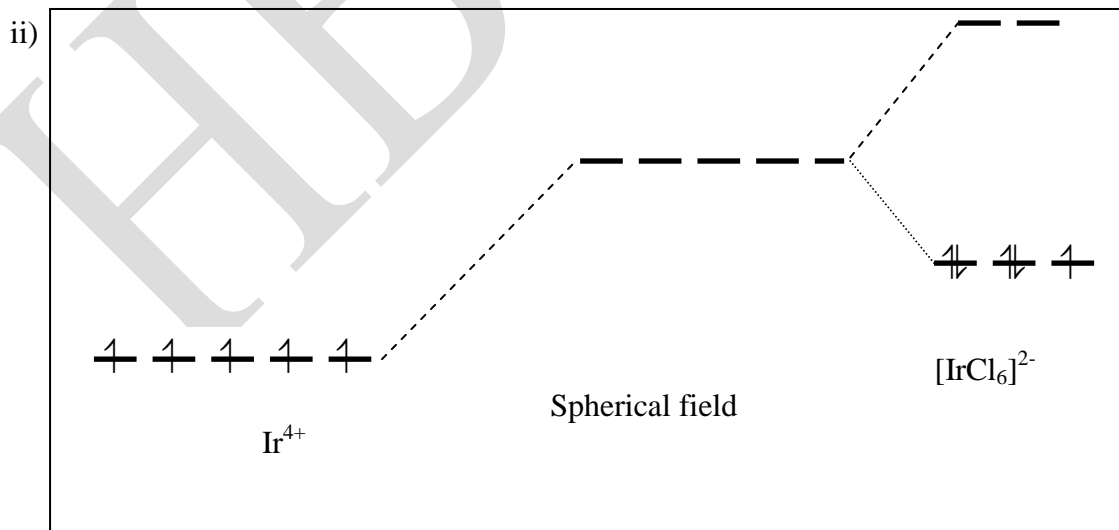

5.7

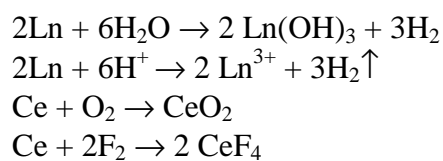

Problem 6

16 Marks

Chemistry of unusual organic compounds

6.1

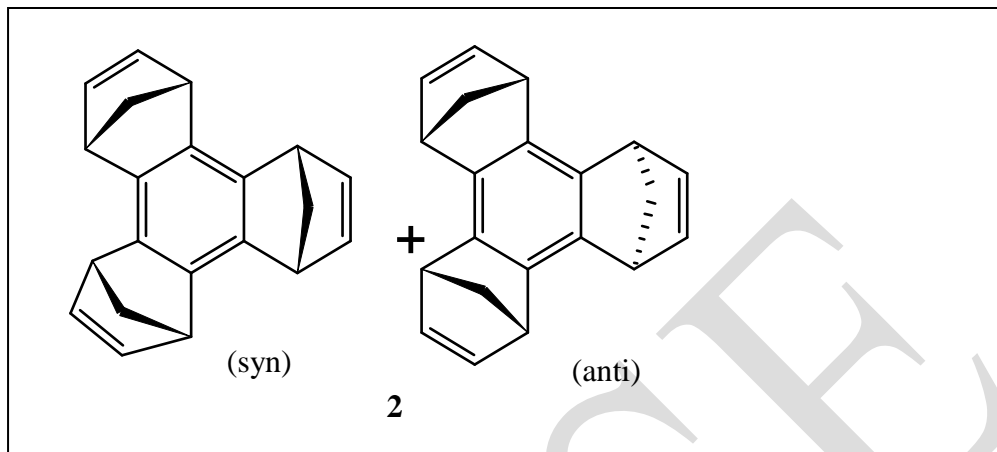

6.2

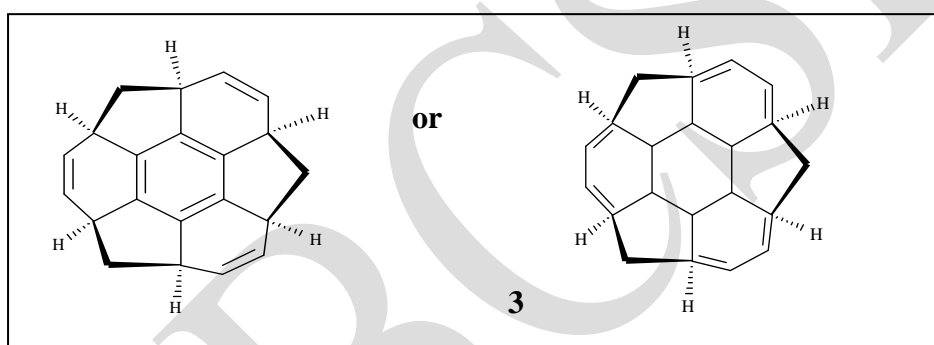

6.3

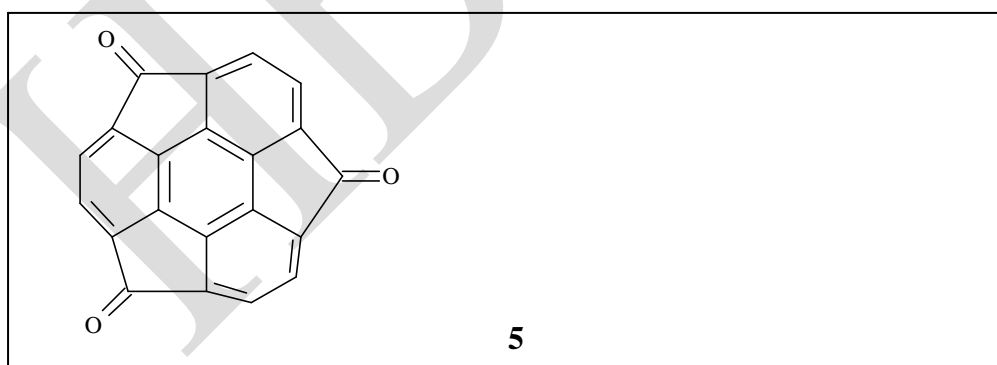

6.4 (i) carbonyl group (b) has conjugated double bond

X

6.5

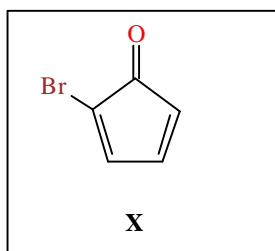
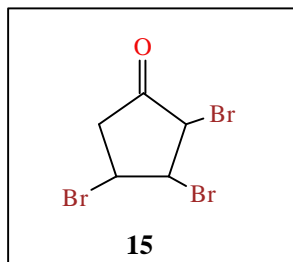
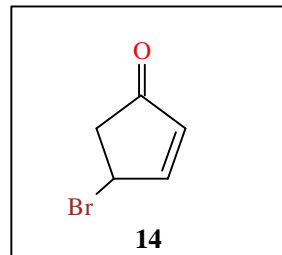
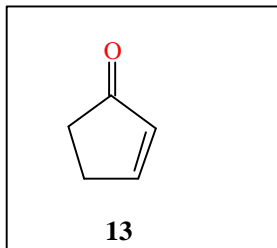
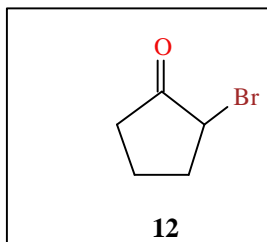

6.6

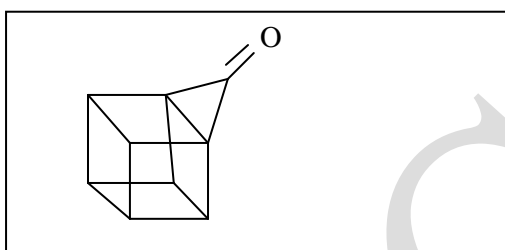

6.7

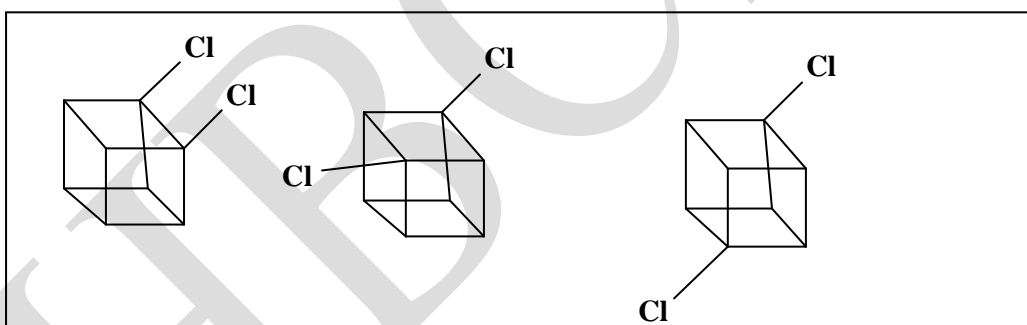

6.8

(ii) pentacyclic compound X

6.9

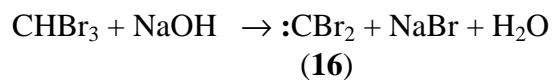

6.10

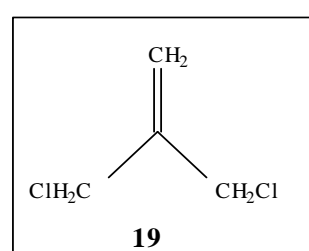
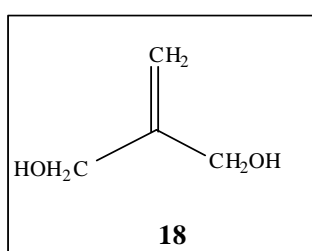
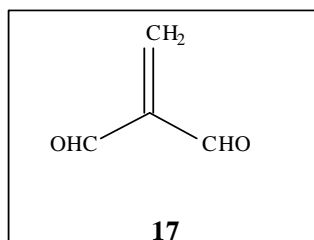

6.11

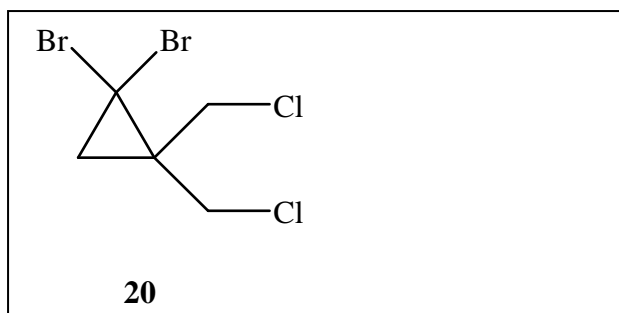

6.12

